

## Sink Phantom Base

Recommended for 20 mm thickness

Kitchen Sinks

Code: 5554 240



### DETAILS

Material AISI 304 stainless steel

---

Texture Foster brushed

---

Dimensions 446 x 446 mm

---

Number of bowls 1 bowl

---

Bowl dimension 406 x 406 mm

---

Built-in hole [View technical data sheet](#)

---

Standard fittings Drain, Foster overflow and universal corrugated pipe (for installing different overflows), Boxed packing

---

Waste fitting 3,5" drain

---

Notes: For 20 mm thick sheets

---

## FEATURES

### PHANTOM BASE - 20 mm

The Phantom BASE sink's bottoms are specifically engineered to be coupled with sinks made out of slabs. The perimetric trough makes for a simple and perfect installation. This version of Phantom BASE is meant for slabs of 20mm thickness.

---

### PHANTOM BASE WITHOUT WELDING

The steel bottom Phantom BASE solves the problem of water draining of slab sinks, because the slope built into the moulded bottom ensures perfect draining. The radius and sloped profile of Phantom BASE guarantee great practicality and hygiene in everyday cleaning.

---

### High thickness

1mm thick steel. A significant thickness, which guarantees the maximum sturdiness and durability.

---

### Perimetral overflow

The overflow is always a security on the Foster sinks that prevents the overflow of water in case of oversights. The perimeter drain solution improves aesthetics thanks to its square and essential shape.

---

## TECHNICAL DATA

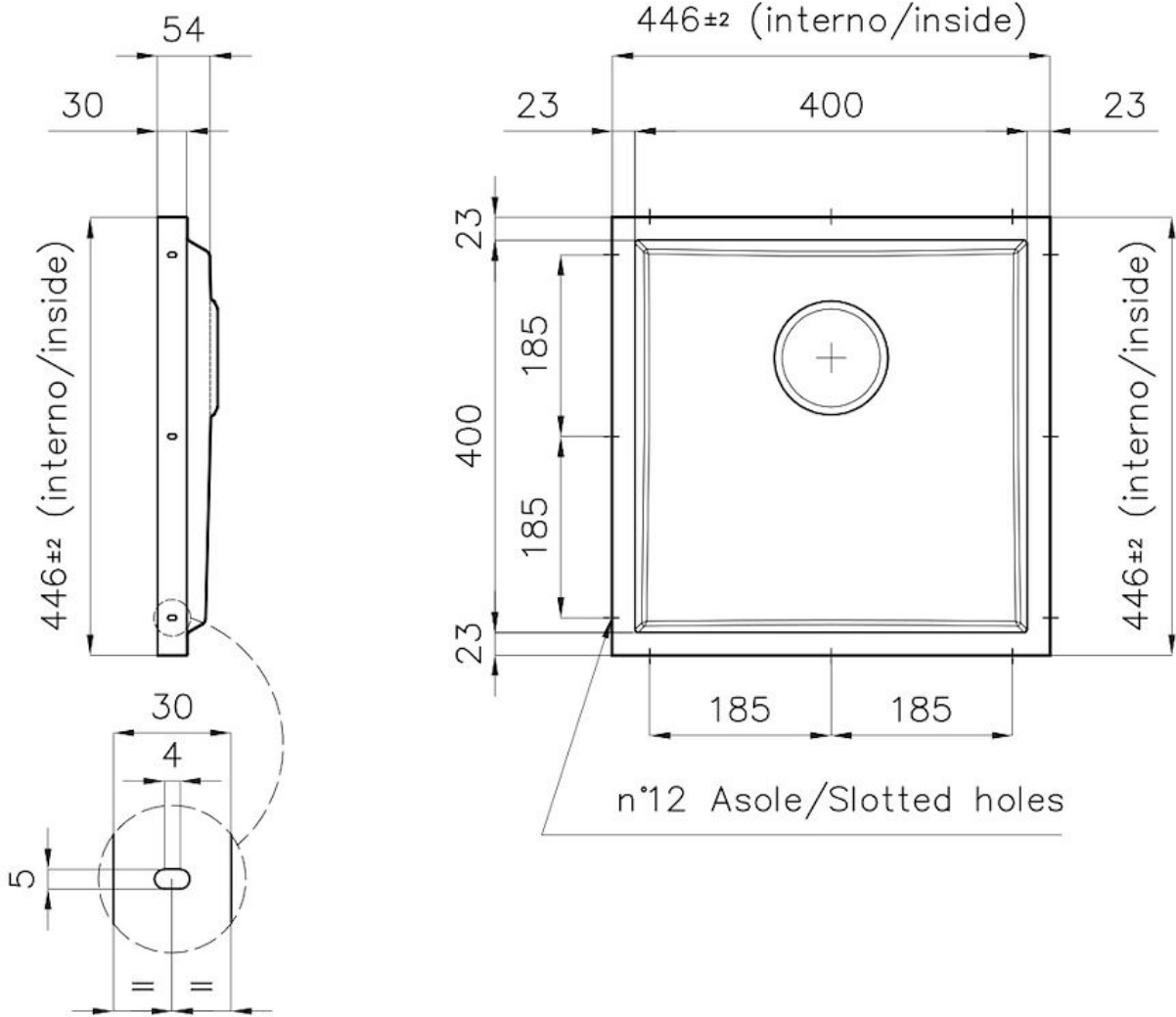

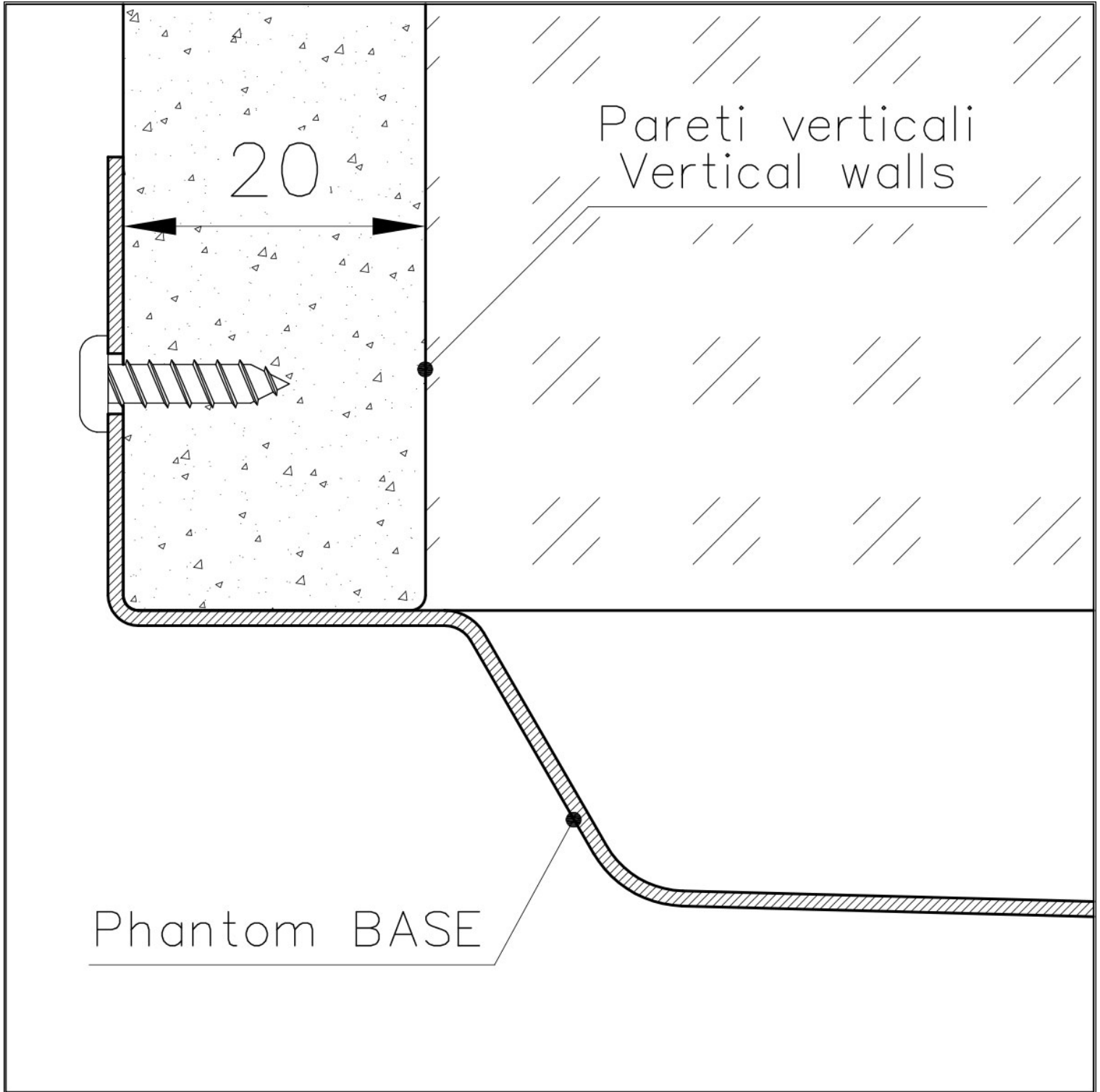



DETTAGLIO PER TROPPO PIENO / OVERFLOW DETAILS

## GALLERY



## OPTIONAL ACCESSORIES



**Cestello inox**  
8612 000



**Griglia Black**  
8100 651



**HPDE Chopping board**  
8657 001



**Stainless steel plate rack**  
8100 201



**White bowl**  
8153 100

## RECOMMENDED PAIRINGS

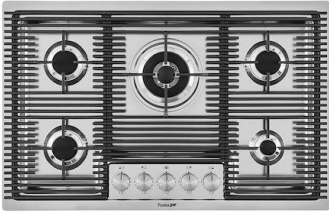

**Cooker hob Milanello 5F**  
7682 000



**Mixer Tap Omega Plus**  
8497 020

## OPTIONAL AUTOMATIC WASTE FITTINGS



**Space Light automatic waste fitting  
- PL**  
8407 117



**Space Push automatic waste fitting  
- PP**  
8407 116



**Space automatic waste fitting - PA**  
8407 108



**Automatic waste fitting**  
8407 100



**Automatic waste fitting**  
8407 000